



Battery protection

Ordercode 10060

CONTENT

1	PICTURE	3
1.1	GENERAL	3
1.2	TOP	ERROR! BOOKMARK NOT DEFINED.
2	MECHANICAL SPECIFICATIONS	4
3	ELECTRICAL SPECIFICATIONS	5
3.1	GENERAL	5
3.2	INPUT VOLTAGE	5
3.3	INPUT CONNECTORS	6
3.4	OUTPUT CONNECTOR	7
3.5	FUSES ON BOARD	8
4	SERVICE AND MAINTENANCE	9
4.1	SAFETY PRECAUTIONS	9
4.2	CLEANING	9
4.3	MONITORING	9
5	TROUBLESHOOTING	11
6	SPECIFICATIONS	12
6.1	ELECTRICAL	12
6.2	ENVIRONMENTAL	12
7	WARRANTY	13
7.1	APPLICATION OF WARRANTY	13
7.2	RMA PROCEDURE	15
8	USED LIST OF ABBREVIATIONS	16

1

Picture

1.1 General

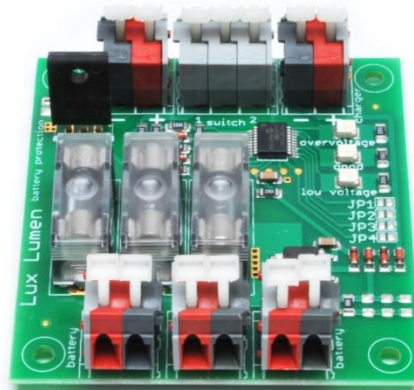
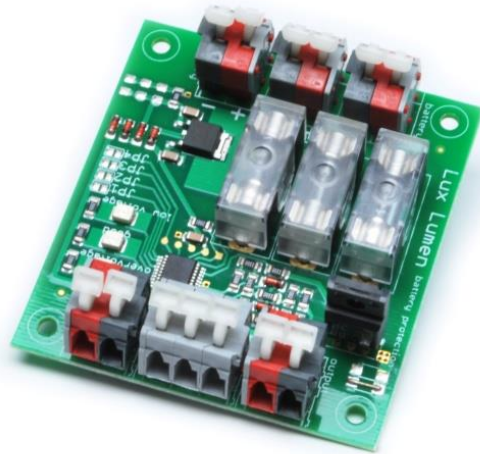

2

Mechanical specifications

- Dimensions: 72 x 77,4 mm
- Max height of electronics: 28,5 mm
- Weight: 69,5 gr

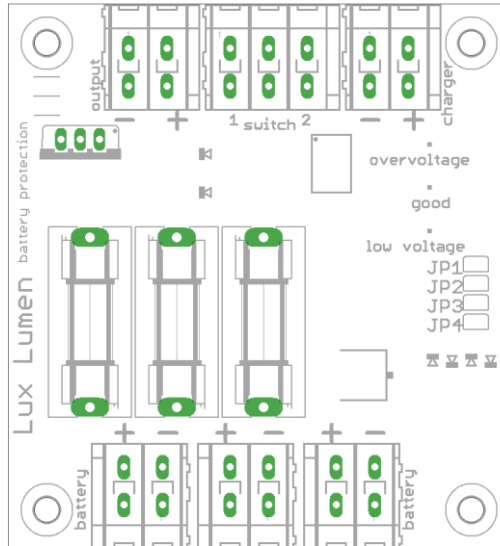

Electrical specifications

3.1 General

The battery protection board is used to connect batteries to a ledstrip.

Features

- The board protects the battery by the use of fuses
- The board avoids using the battery at too low voltages
- The board allows easy switching between charging the battery, turning the device on and off

3.2 Input voltage

The battery protection board can work at different voltages.

Specify the desired output voltage when ordering the battery protection board.

The hardware and the software of the board will be configured on the desired battery voltage.

Typical output voltages: 7,2 V, 9,6 V, 12 V

Nominal voltage	Voltage on (V)	Voltage off (V)	Voltage max (V)	Type of battery	Number of cells
7,2 V	7,2	6	8,5	NiMh	6
9,6 V	9,6	8	11,6	NiMh	8
12 V	12	10	14	Pb	6

Note: Use a charger adapted to the battery type.

3.3 Input connectors

The battery protection board has three different inputs.

Battery input

There are three battery inputs on the board. Multiple battery units can be used on the board. The inputs are parallel connected on the board.

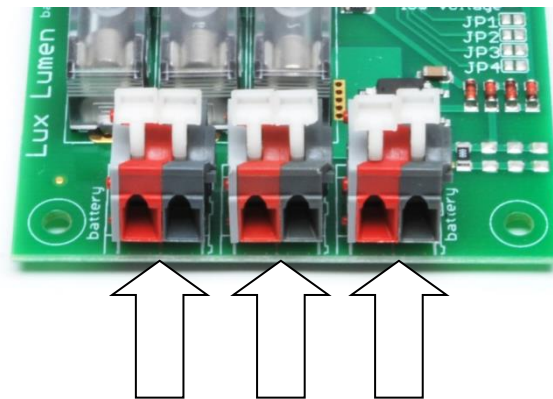

Note: Watch out for polarity

Charger

The right charger must be connected to the charger input of the board. A battery charger must be used that corresponds to the specifications of the batteries

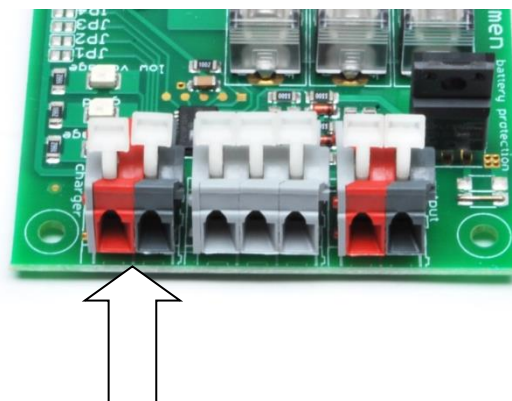

Switch

A three position switch must be connected to the battery protection board.



The switch can change the state of the output. There are three possible positions:

- Charging: the battery packs will be charged (no output)
- On: the battery is connected to the output with protection
- Off: the battery is disconnected from the output

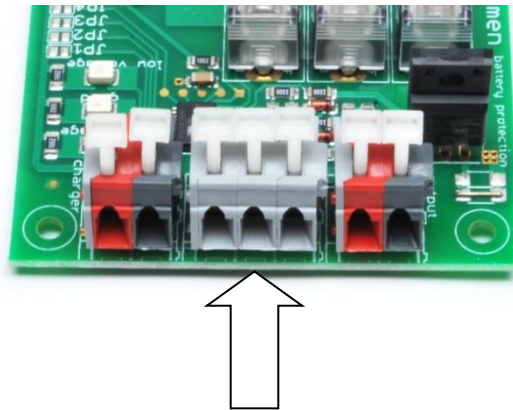

3.4 Output connector

The battery protection board has one output. This output must be connected to the device (e.g. LED fixtures)

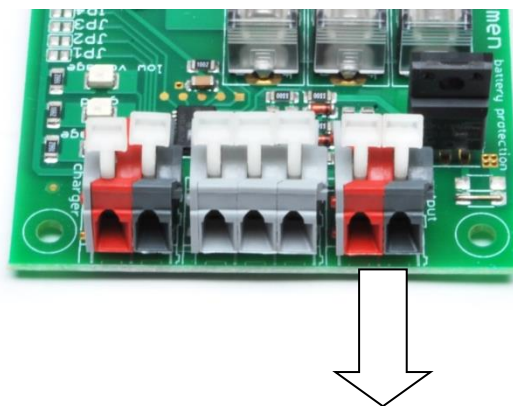

Note: Watch out for polarity

3.5 Fuses on board

There are three fuses on board to protect every battery input

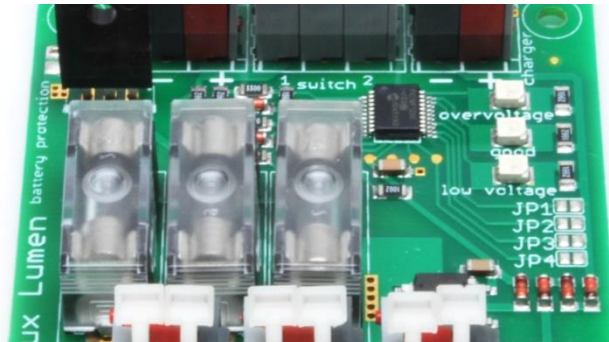

Only replace the fuse with the same type and current installed in the battery protection board.

Service and maintenance

4.1 Safety precautions



Read carefully the safety information in this manual. Lock out the power on the entire system and allow all electronic devices to discharge and cool down before executing any service or maintenance.

4.2 Cleaning

Battery protection itself

Extensive dirt and particle build-up degrades performance and may cause overheating. This can result in damaged board and power supply's. Damage by inadequate cleaning or maintenance is not covered by the product warranty.



Never use solvents to clean the outer housing of the card.

Never use water or wet cloth.

Enclosure in which the board is integrated

Best is to use compressed air to remove dust or soft cloth to remove the dust in the cabinet. When using compressed air care must be taken not to damage the fans in the enclosure. Never use solvents to clean the outer housing of the enclosure.

4.3 Monitoring

Three LED's are located at the side of the battery protection board.



The LED's indicate the status of the board like shown here below:

Name LED	Over voltage	Good	Low voltage
Status led =ON	The voltage of the battery is to high	Normal operation	The voltage of the battery is to low
Status led =Off	N/A	N/A	N/A

Troubleshooting

Indication	Status of led	Problem	Action
Low voltage	On	The voltage of the battery is to low	Charge the battery. Turn the switch to the charge position
Overvoltage	On	The voltage of the battery is to high	Check the connected battery. Wrong voltage or the board is configured for another voltage
No output voltage	N/A	No battery connected	Connect the right battery to the battery input
No output voltage	N/A	Position of the switch	Check the position of the switch
No output voltage	N/A	Fuses broken	Replace the fuses with the same voltage and current

Specifications

6.1 *Electrical*

Inputs

- Three battery inputs
- Max. 4 A for every battery input
- Inputs on Cage clamp[®]
- Three position switch input
- Battery charger input
- Status LED's for low voltage or overvoltage
- Separated fuse for every battery input

Output

- 1 output
- Output on Cage clamp[®] for easy connection

6.2 *Environmental*

- IP rating: IP 20
- Humidity: 30% to 95%
- Ta (max): +40 °C (104 °F)
- Ta (min): -15 °C (+5 °F)

Warranty

7.1 Application of warranty

Warranty period

Warranty service is valid for one year from the date of purchase by the consumer, as evidenced by invoice date given out by your point of sale.

Warranty service

Service under warranty can only be done by Lux Lumen.

Coördinaties:

Lux Lumen
Kernenergiestraat 53 A
2610 Wilrijk
Belgium

Any cost of secure transportation of the product to and from Lux Lumen service department, will be borne by the customer.

Limitations

Lux Lumen will not warrant the following:

- Periodic check-ups, maintenance and repair or replacement of parts due to normal wear and tear.
- Consumables
- Any software
- Defects caused by modifications carried out without Lux Lumen's approval.
- Damage resulting from the fact that a product is not conforming to country specific standards or specifications in another country than the country of purchase.

Costs incurred by Lux Lumen's service center in making any adoptions or modifications of a product necessary for country specific technical or safety standards or specifications, or any other cost to adjust the product as a result of any specifications which have changed since the delivery of the product.

Warranty service is excluded if damage or defects have been caused by:

Improper use, extensive use, handling or operation of the product as referred to in the user manual or operator manual and/or relevant user documents, including without limitation, incorrect storage, dropping, excessive shocks, corrosions, dirt, water, or sand damage, if the product is not rated to be used in severe conditions, indicated by its IP and IK degree, mentioned in the product specifications in this manual.

Repairs, modifications or cleaning carried out by a non Lux Lumen service centre.

Use of spare parts, software or consumables, which are not compatible with the product.

Connecting the product to equipment not intended to be used with this product.

Defects caused by improper condition of the power supply network.

Inadequate packaging of the product when returning it under the RMA procedure.

Accidents or disasters or any cause beyond the control of Lux Lumen, including but not limited to lightning, water, fire, public disturbances, improper ventilation, and acts of god.

Others

It is the responsibility of the customer to backup and save any software files and programs before repair and to restore the same after such repair.

This warranty does not affect the consumer's statutory rights under applicable national legislation in force, nor the consumer's rights against the retailer arising from the sales/purchase contract. In the absence of applicable national legislation, this warranty will be the consumer's sole and exclusive remedy, and Lux Lumen cannot be liable for any incidental or consequential damages for breach of any express or implied warranty of this product.

For full details of the warranty offered on this product, please contact Lux Lumen's service center.

7.2 RMA procedure

To send material back to Lux Lumen, you need a RMA (Return Material Authorization) document that you will receive from Lux Lumen.

Without the RMA document, we cannot accept the material.

The procedure to obtain a RMA:

Step 1:

Customer contacts Lux Lumen about warranty, defects if material has to be returned.

Step 2:

Lux Lumen sends the customer a filled out RMA document (using a unique RMA number)

Step 3:

Customer sends material (include a copy of the RMA document with the material)

Step 4:

Lux Lumen evaluates the problem, and informs the client if repair is done under warranty, or makes an offer to the client for repair.

Step 5:

The procedure related to lux lumen quality procedures, according ISO 9001 is started up.

Used list of abbreviations

- PCB: printed circuit board
- DC: Direct current
- DIN-rail: rail used in electrical installation according to 'Deutsche Industry Norm' specifications