



Current LED driver

12 channel 700mA

Ordercode: 10128

CONTENT

1 PICTURE	3
1.1 GENERAL	3
1.2 TOP	ERROR! BOOKMARK NOT DEFINED.
2 DIMENSIONS	4
3 SAFETY INFORMATION	5
3.1 SYMBOLS.....	5
3.2 PROTECTION FROM ELECTRIC SHOCK	6
3.3 PROTECTIONS FROM FIRE AND BURNS	6
3.4 PROTECTION FROM INJURY.....	7
3.5 DISPOSING OF THIS PRODUCT	7
4 PHYSICAL INSTALLATION	8
4.1 UNPACKING	8
4.2 LOCATION AND ORIENTATION.....	8
4.3 MOUNTING	8
5 EXTERNAL CONNECTIONS	10
5.1 DC POWER INPUT	10
5.2 DC POWER OUTPUTS	13
5.3 REMOTE ADDRESSING BOARD INPUT	15
5.4 DMX IN AND OUTPUT	16
6 EMC AND SAFETY REQUIREMENTS	19
7 INSTALLATION SETUP	20
7.1 GENERAL DESCRIPTION.....	20
7.2 TYPICAL LAYOUT.....	20
8 CARD CONFIGURATION	21
8.1 DMX START ADDRESS SETTING	21
8.2 CHANNEL MODE OPERATION	22
8.3 STAND ALONE OPERATION OF THE CARD	24
9 SERVICE AND MAINTENANCE	26
9.1 SAFETY PRECAUTIONS	26
9.2 CLEANING.....	26
9.3 MONITORING	26
9.4 FUSE REPLACEMENT.....	27
9.5 SOFTWARE UPDATES	28
10 TROUBLESHOOTING	29
11 SPECIFICATIONS	30
11.1 ELECTRICAL.....	30
11.2 ENVIRONMENTAL.....	30
11.3 EXTRA FEATURES.....	30
11.4 MECHANICAL.....	31
12 WARRANTY	32
12.1 APPLICATION OF WARRANTY.....	32
12.2 RMA PROCEDURE.....	34
13 USED LIST OF ABBREVIATIONS	35

Picture

1.1 General

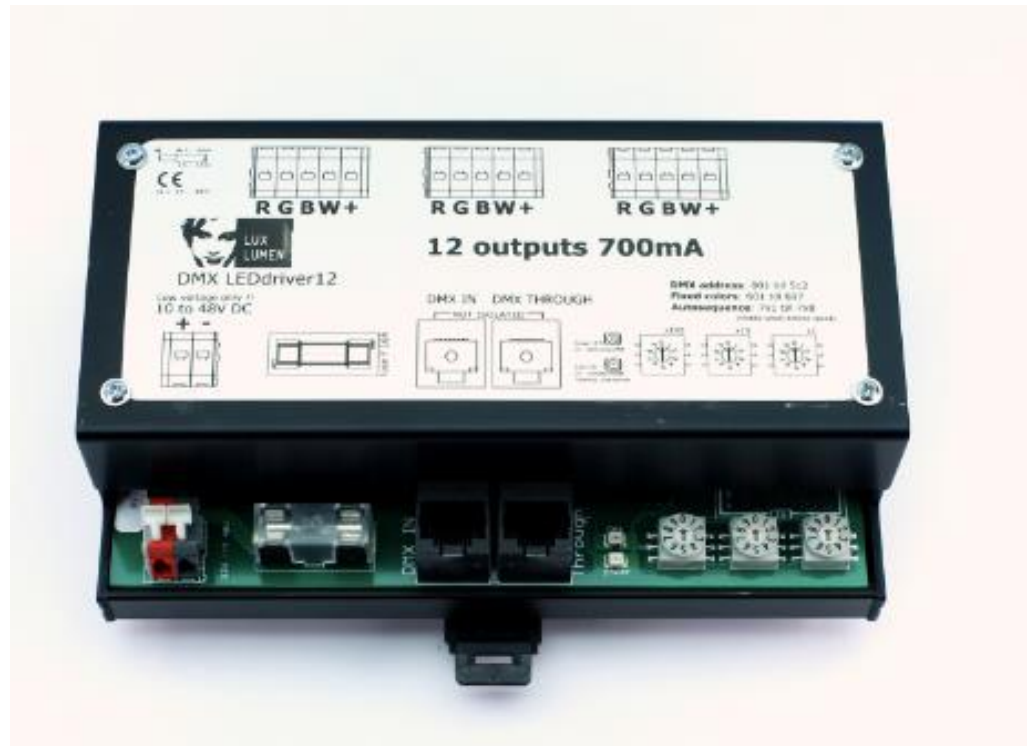

2

Dimensions

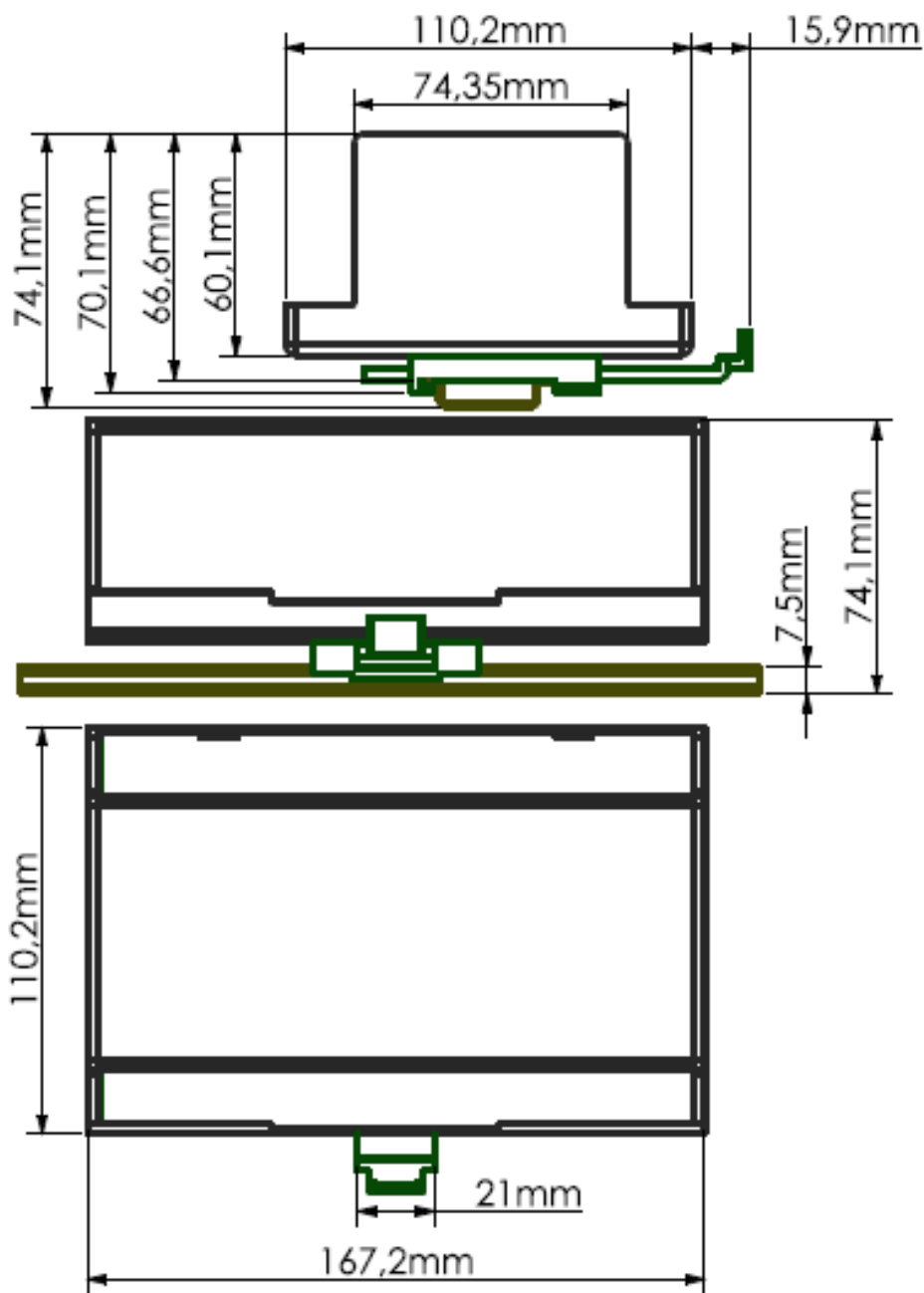

Please note, dimensions given are din-rail included.

Safety information

Before installing, powering up, or servicing this LED driver card, it is highly recommended that you read this manual and ensure yourself that you completely understand its content. Observe the safety precautions in this manual. Install and operate the led driver only as described in this manual, and in conformity with local regulations. If you have any questions how to operate this product safely, please contact your point of sale.

3.1 Symbols

Following symbols are used to identify important safety information on the product and in this manual.



DANGER!
Safety hazard. Risk of severe injury or death.



Warning!
Hazardous voltage. Risk of lethal or severe electric shock.



Warning!
LED light emission. Risk of eye injury.



Warning!
Burn hazard. Hot surface. Do not touch



Warning!
Refer to user manual.

3.2 Protection from electric shock



Although this card itself does not operate with dangerous voltages, the installation in which is intended to be used, can contain dangerous voltages. Shut down the power of the complete installation before carrying out any installation, or maintenance work.

Please note that all metal parts used in the enclosure, where this card is mounted are firmly grounded.

Use only AC to DC power sources, suitable for the application and conform to local regulations. Please ensure yourself that the AC to DC power supply is able to deliver the rated current requirements of the installation.

If any cable, seal or housing is damaged, cracked or reformed, disconnect the power of the installation immediately.

The LED driver card is only to be used in a proper housing conform to local regulations.

For any additional servicing, not described in this manual, please contact your point of sale.

3.3 Protections from fire and burns



Do not operate this LED driver card if ambient temperatures, inside its enclosure, is above 45 °C (113 °F). Please ensure yourself that sufficient ventilation around the card is possible.

It might be necessary to allow the LED driver card to cool down for 5 minutes, before servicing.

Do not modify the card, in a way, not described in this manual.

Never bypass the fuse or change the fuse with another type or value as is rated in this manual.

3.4 Protection from injury



Ensure yourself that all components, covers are securely fastened. Verify that the card is firmly clicked on a standard din-rail.

3.5 Disposing of this product



This LED driver card is manufactured in compliance with directive of the European community: waste electrical and electronically equipment. Please help to preserve our environment and ensure that this product will be recycled properly at the end of its life.



Physical installation

Thank you for selecting this LED driver card as best solution in your setup.

Warning! Read the safety precautions in this manual before integrating this card into your installation.

Installation must be carried out by qualified professionals only.

Assure yourself that there is sufficient and unrestricted air flow around the LED driver card.

4.1 Unpacking

The following items are included in your package:

- Led driver-card
- Carton box package
- Short form manual

4.2 Location and orientation

This LED driver card cannot be used without additional protective housing. The housing protects the user against electrical shocks, and it is protecting the card against climatologically influences.

Please assure yourself that the cabinet, which houses the LED driver card is according to local regulations and laws of the country of installation.

It is advised to install the card in horizontal position on the din-rail.

4.3 Mounting

The LED driver can be mounted on a standard 35 mm top hat din-rail. A typical section of this din rail can be found here:

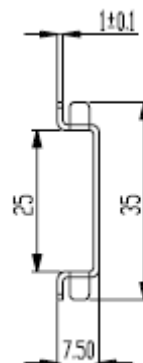

Note: Use end blocking clamps if necessary, in your application.

The LED driver card is designed for architectural purposes in fixed installation. To remove the LED driver card from the din-rail, gently move the mounting clip like indicated below:

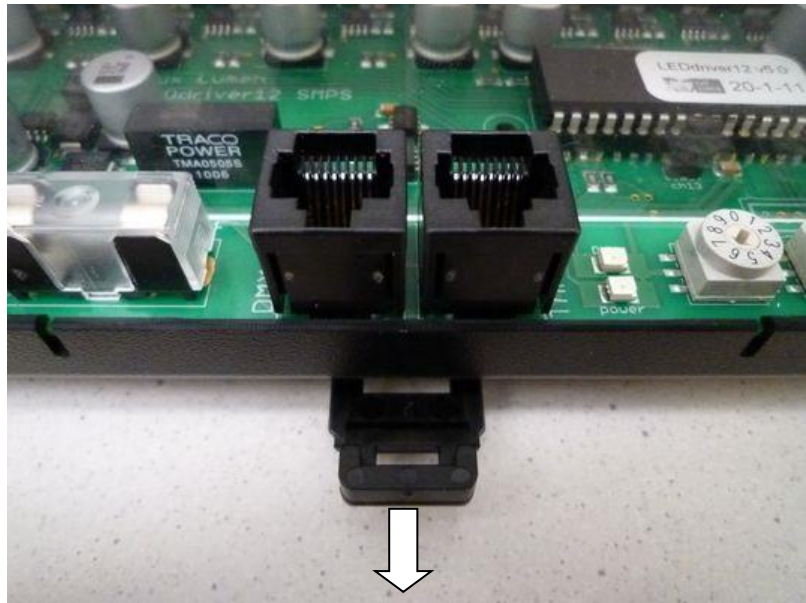

If the product is used in a situation where heavy mechanical shocks can be expected, we advise to remove the plastic din-rail enclosure and bolt the LED driver PCB directly on a metal base. Use bolts and nuts M3 to attach the LED driver. Use proper spacers to avoid electrical contact between solder pads, and the metal parts of the housing.

Assure yourself that no metal parts of screws or bolts make contact with the electrical circuits on the printed circuit board.

The nine mounting holes can be found below in the red color:

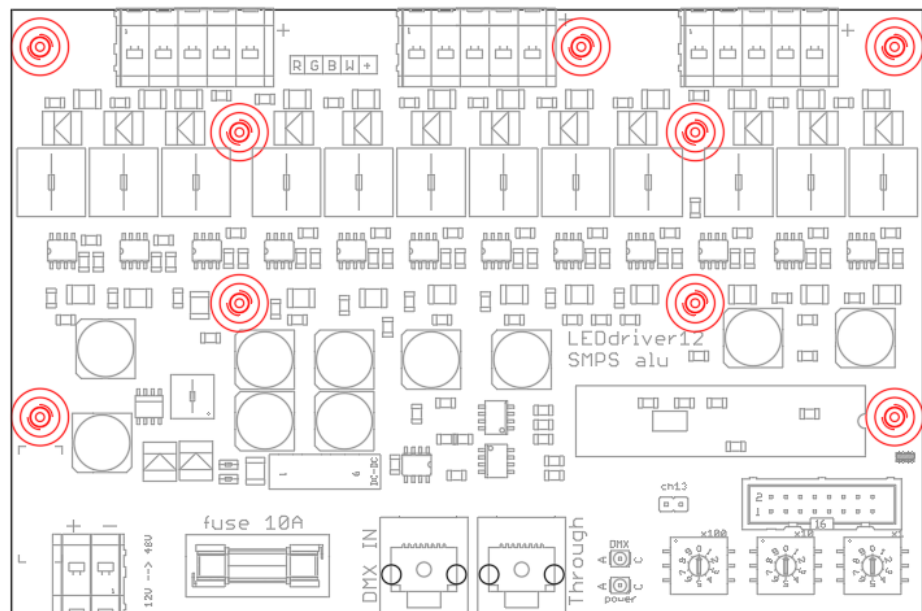

In case of problems or doubts, please contact your point of sale.



External connections

5.1 *DC power input*

Safety precautions

Never connect the live power on the input terminals of the LED driver card!
In case of doubts, contact your point of sale.

Polarity

Please observe the polarity at the power supply input terminals. Improper connection might damage the card, and power supply permanently. In case of inversed polarity, warranty is void.

The colour coding can be found below:

Clamp position	Colour coding of clamp	Polarity symbol	Name of polarity
Left	Red	+	Positive
Right	Dark grey	-	Negative

Note: In the correct orientation the text is readable on PCB.

Physical connections

The card itself is operating into the range 10 volt tot 48 volt DC.

The cable section of the power feeding cable must be in the range like given in the table below:

Connection technology	Cage Clamp®
Conductor size: solid	0.08-2.5 mm ²
Conductor size: fine-stranded	0.08-2.5 mm ²
Conductor size: fine-stranded	0.25-1.5 mm ² (with insulated ferule)
Conductor size: fine-stranded	0.25-1.5 mm ² (with un-insulated ferule)
AWG	28-12
Strip length	5-6 mm/0.20-0.24 in
Conductor entry angle	0° to PCB

Note: Cage clamp® is a trade mark of Wago contact technology.

Requirements power supply: Rated voltage

As a rule of thumb, the voltage range of the input of the power supply is situated in the range:

Voltage input in volt	Quantity of led's
12	1
12	2
12	3
24	4
24	5
24	6
48	7
48	8
48	9
48	10
48	11
48	12
48	13
48	14
48	15

If different colours or quantity's of leds are used at one LED driver card, the highest voltage input is applicable.

Please note that you can calculate the power supply input, by following formula:

$$\text{➤ } U_s = (U_f \times Qty) + 2 \text{ (volt)}$$

Abbreviations and units used in this equation are listed below:

abbreviation	full name	description	unit
U_s	$U_{\text{powersupply}}$	The minimum required voltage of the power supply, driving the LED driver card	Volt
U_f	U_{forward}	The forward voltage or the actual leds used in your setup. Please refer to the manufactor	Volt
Qty	Quantity	Number of leds connected in series to one output.	Number

Required power supply: current power

The AC/DC power supply has to be able to drive sufficient power required in your setup.

$$\text{➤ } P_s = (P_l \times Qty) + 10 \text{ (watt)}$$

Abbreviations and units used in this equation are listed below:

abbreviation	full name	description	unit
P_s	powersupply	The minimum required power of the power supply, driving the LED driver card	Watt
Qty	Quantity	Number of leds connected in series to one output.	Number
P_l	P led	Power of the LED	Watt

5.2 DC power outputs

Safety precautions



Never connect the live power on the output terminals of the LED driver card!

Never connect other devices as the correct type of leds to the outputs of the LED driver card.

In case of doubts, contact your point of sale.

Polarity



Please observe the polarity at the LED driver output terminals. Improper connection might damage the card, and leds permanently. In case of inversed polarity, warranty is void.

The positive polarisation is the common line in the led-string in case of use as RGBW modules in a 5-wire system.

The positions of the clamps:

Clamp position	Polarity symbol	Name of polarity
Left (1)	R	Red (negative polarity)
Left (2)	G	Green (negative polarity)
Middle	B	Blue (negative polarity)
Right (2)	W	White (negative polarity)
Right (1)	+	Common (positive polarity)

Note: In the correct orientation the text is readable on the PCB.

Physical connections

The card itself is operating into the range 10 volt tot 48 volt DC.

The cable section of power feeding cable must be in the range like given in the table below:

Connection technology	Cage Clamp®
Conductor size: solid	0.08-2.5 mm ²
Conductor size: fine-stranded	0.08-2.5 mm ²
Conductor size: fine-stranded	0.25-1.5 mm ² (with insulated ferule)
Conductor size: fine-stranded	0.25-1.5 mm ² (with un-insulated ferule)
AWG	28-12
Strip length	5-6 mm/0.20-0.24 in
Conductor entry angle	0° to PCB

Note: Cage clamp® is a trade mark of Wago contact technology.

Cable length / min sections from LED driver to led string

The minimal section of the cable is given by following table:

Cable function	Max current	Min section
Red	700 mA	0.25 mm ²
Green	700 mA	0.25 mm ²
Blue	700 mA	0.25 mm ²
White	700 mA	0.25 mm ²
Common	2800 mA	0.25 mm ²

5.3 Remote addressing board input

Safety precautions



Never connect other devices as the remote addressing board to this input.

In case of doubts, please contact your point of sale.

Specifications

If an external addressing board is used, the rotary switches on the LED driver board must be set at:

➤ 0 (x100) 0(x10) 0 (x1)

This input is used when the addressing wheels cannot be situated at the PCB board itself. Mostly this occurs when the card is used in metal housings, like a standard 19-inch rack unit.

You can find a picture of this remote addressing board below:

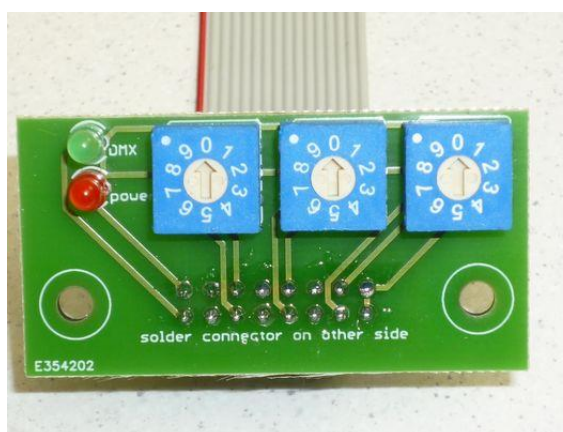

Suitable connector and cable

In cases in which the remote addressing board will be used, a special connector needs to be soldered on the PCB. For more information, contact your point of sale.

When using the remote address-PCB, the card cannot be used in its standard plastic housing.

The maximum length of the 16 pole flat-cable shall not exceed 50 cm in length.



5.4 DMX in and output

Precautions

Never connect other devices as a DMX transmitter or receiver to this input and output.

In case of doubts, please contact your point of sale.

Specifications

The use of Cat.5 or Cat.6 cable with according connectors is conformal the DMX 2004 by USITT in fixed installations. For more detailed information: www.usitt.org

The benefits are:

- Low cost of connectors
- Low cost of cabling
- Worldwide availability
- Fast application on site
- Very well known by electrical contractors
- Reliable connections

When the card operates in DMX-mode and the DMX-signal should be corrupt or not present, after 1 minute all outputs will go to 0% and remain in that status till the DMX-signal is restored properly.

Suitable cable for transmission of the DMX-signal

Name of cable	Shielded or not shielded	Remarks regarding shielding	Max run length	Termination above run length (see 7.1)
CAT 5E UTP	Not	No ground connection at output terminals	250 m	100 m
CAT 5E FTP or STP	Yes	Connection of shielding to PE clamp of output terminals	250 m	100 m
CAT 6 UTP	Not	No ground connection at output terminals	250 m	100 m
CAT 6 FTP or STP	Yes	Connection of shielding to PE clamp of output terminals	250 m	100 m

Pin layout of UTP to XLR connectors

XLR pin 1 wired to UTP contacts 7 and 8. UTP wire color usually brown and brown/white for shielding.

XLR pin 2 wired to UTP contact 2. UTP wire color usually orange for data negative connection.

XLR pin 3 wired to UTP contact 1. UTP wire color usually orange/white for data positive connection.

5 pin XLR

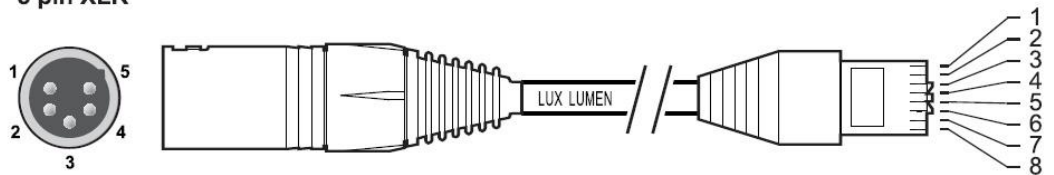

3 pin XLR

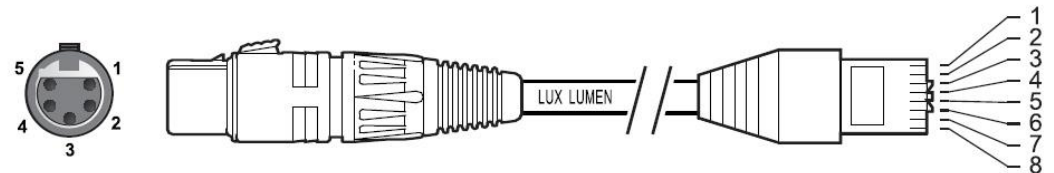

3 pin XLR

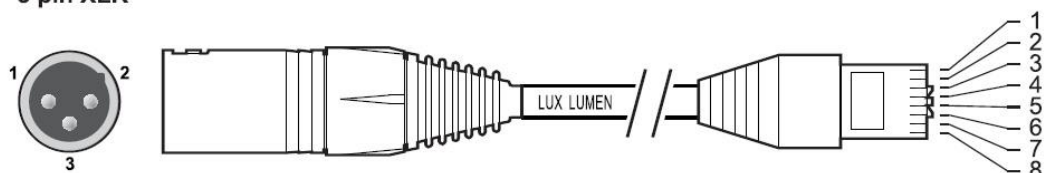

*XLR connectors
front shown*

*Tap on RJ45 connectors
facing away from observer*

Termination of the DMX signal

To avoid disturbance of the DMX-signal it is recommended to terminate the DMX-line at the last open 'through' connector at each physical DMX-line. This is done with an 'end plug'. This end plug consists of a 0.25 watt resistor of 120 ohm between pins 1 and 2 of the connector.

Typical schematic of the end plug can be found below:

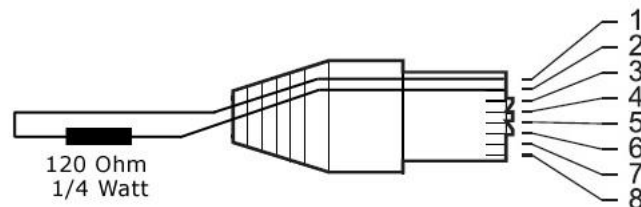

*Tap on RJ45 connectors
facing away from observer*

EMC and safety requirements

The LED driver card is fully compliant to the LVD and EMC directive of the European council, if used in a properly designed setup.

EMC requirements of the power supply:

The LED driver card is only intended to be used in lighting applications, and as such, the complete assembly of led unit and power supply needs to be fully compliant with the harmonized standards.

Immunity according to:

- EN 61547:2009 (General EMC immunity requirements lighting eq.)
- EN 61000-4-1:2006 (General immunity testing techniques)
- EN 61000-4-2:2008 (ESD immunity test)
- EN 61000-4-3:2006 + A1:2007 (Radiated immunity test)
- EN 61000-4-4:2004 (Fast transients and burst immunity)
- EN 61000-4-5:2005 (Surge immunity test)
- EN 61000-4-6:2008 (Conducted immunity test)
- EN 61000-4-8:1993 (Magnetic field immunity test)
- EN 61000-4-11:2004 (Voltage variations immunity test)
- EN 61000-6-1:2005 (Generic standards for immunity)

Emission according to:

- EN 61000-3-2:2005+A1:2008+A2:2009 (Harmonics emission test<16A)
- EN 61000-3-3:2008 (Flicker+ voltage changes limits< 16A)
- EN 55015:2006+A2:2009 (Conducted + radiated emission lighting equipment)

To achieve this compliance, a proper power supply must be supplied. In case of doubts, contact your point of sale.

LVD requirements of the power supply:

The LED driver card is only intended to be used in lighting applications, and as such, the complete assembly of led unit and power supply needs to be fully compliant with following harmonized standards:

- EN 60598: general requirements of lighting equipment.

Installation setup

7.1 General description

The LED driver card is intended to control high-power led-modules at 700mA by a DMX-signal.

At the outputs a set of high power leds, connected in one serial string of per output, is connected.

An external power supply AC → DC will provide the card with the required power.

A DMX controller controls the intensity of the various output channels.

7.2 Typical layout

The drawing given here shows a typical layout when used with high-power RGBW led-modules. Although the application is given for RGBW, the outputs might drive mono-chrome leds of one colour as well.

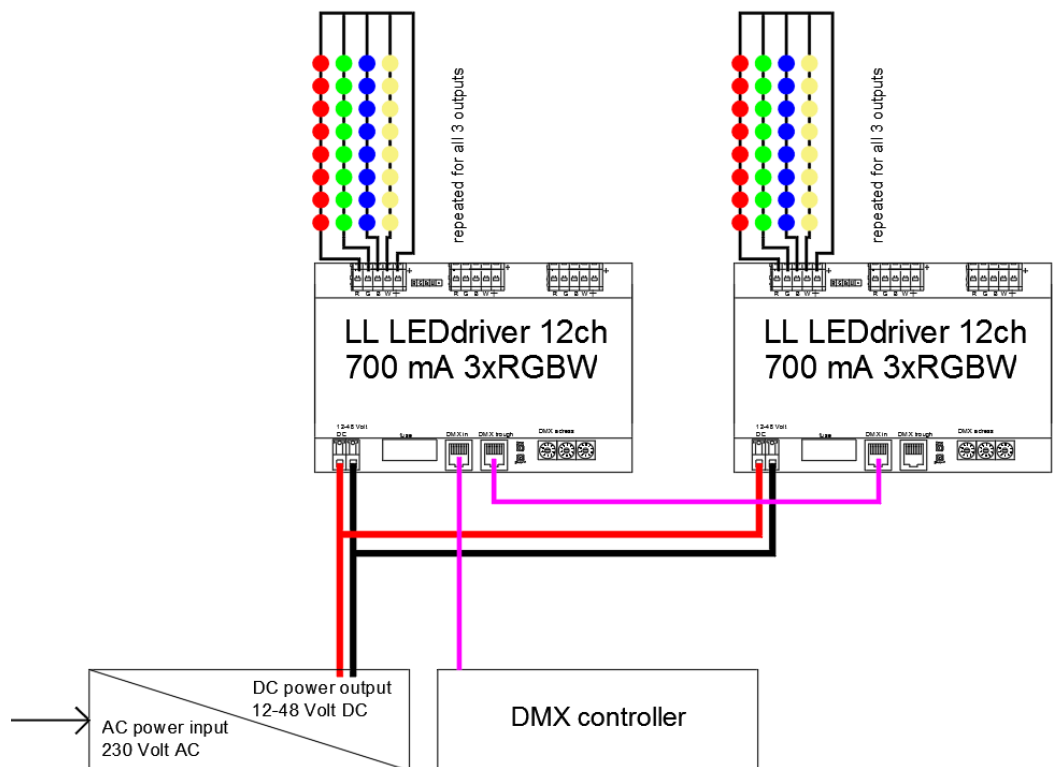

Card configuration

8.1 DMX start address setting

The card uses 12 or 13 DMX channels in one consecutive block.

For example, if the start address is set to 009 and the mode of the card is '12 channel' mode, the addresses of the different led-outputs will be as the table below:

DMX address	Driver card output
009 (address by the rotary wheels)	Led output nr 1
010	Led output nr 2
011	Led output nr 3
012	Led output nr 4
013	Led output nr 5
014	Led output nr 6
015	Led output nr 7
016	Led output nr 8
017	Led output nr 9
018	Led output nr 10
019	Led output nr 11
020	Led output nr 12

The picture below shows the rotary address setting wheels.



Note: If the card is oriented that the text on the PCB is readable, the positions of the wheels will affect following address-setting:

- Left wheel is hundreds (x100)
- Middle wheel is tens (x 10)
- Right wheel is units (x 1)

On the picture above the start address is set to 009.

When using the DMX controlled mode of the card, the highest DMX start address that can be set is 501. If a start address is higher as 501 is used, the corresponding channels with a virtual address number higher as 512 will not react on any changes in the DMX values.

8.2 Channel mode operation



Safety precautions

The use of the stroboscopic functions may cause dangerous situations for persons with high epileptic risk.

Features

The card can be used in 12 channel mode or in 13 channel mode. In 12 channel mode, each DMX value is controlling 1 output intensity of the LED driver card.

In the 13 channel mode, the first 12 channels are controlling the intensity of the 12 outputs. The 13th channel is used as effect channel, which activates effects on the previous 12 channels.

Graphically you can see the different effects below:

Ch13		
248 - 255	97% - 100%	All on
192 - 247	75% - 97%	Random strobe 2 - 17 Hz
128 - 191	50% - 75%	CMY strobe 2 - 20 Hz
64 - 127	25% - 50%	Full strobe 2 - 20 Hz
0 - 63	0% - 25%	All on

Setting of card to 13 channel mode



Before changing the setting from 12 to 13 channel mode, assure yourself that all live power is disconnected from the installation.

Changing the card from 12 to 13 channel mode can only be done by a proper skilled professional, having adequate tools to do this.

If you are not sure how to do this, ask assistance at your point of sale.

Remove the green printed circuit board completely from its aluminum housing (both the cover and black aluminum part of the housing).

On the top of the PCB (printed circuit board), you will find two empty solder holes, marked with CH 13 under it.

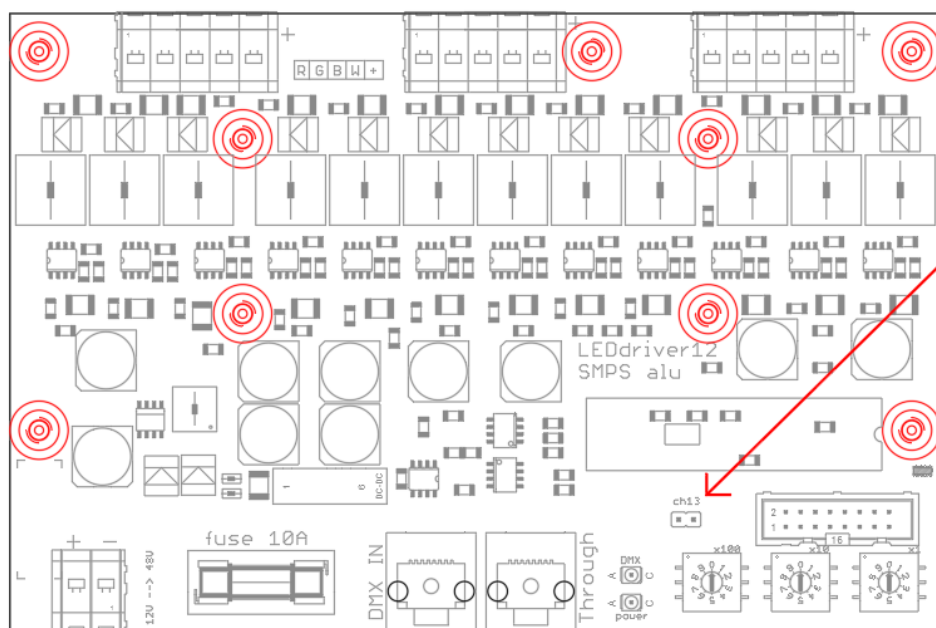

An electrical contact must be made between the two solder-pads, located at the bottom of the LED driver board. This needs to be done by soldering a small link between those two pads. Best practice is to solder a small piece of blank wire between the two pads.

8.3 Stand alone operation of the card

Features

When the card is operated without an external DMX signal, following functions can be activated by setting the address wheel to the appropriate number.

- 7 Different basic colors at 100% output
- A selection of 9 different dynamic programs, each with 9 different speeds
- Is only to be operated connecting RGB led-modules. The colors need to be connected accordingly:
 - Red to channels 1, 4, 7 and 10
 - Green to channels 2, 5, 8 and 11
 - Blue to channels 3, 6, 9 and 12

Functions in the range of 6 X Y → statically scenes



6	0 = 100% intensity	0 = all channels off
6	1 = 10% intensity	1 = all red
6	2 = 20% intensity	2 =all yellow (red+green)
6	3 = 30% intensity	3 =all green
6	4 = 40% intensity	4 = all cyan (green+ blue)
6	5 = 50% intensity	5 = all blue
6	6 = 60% intensity	6 =all magenta (red+blue)
6	7 = 70% intensity	7 =all white (red+green+blue)
6	8 = 80% intensity	8 = not used
6	9 = 90% intensity	9 = not used

Functions in the range of 7 X Y → dynamical programs



7	0 = not defined	0 =RGB fading no step between
7	1 = 10% speed = slowest	1 =RGB fading 1 step between
7	2 = 20% speed	2 =RGB no fade, no step between
7	3 = 30% speed	3 =RGB no fade, 1 step between
7	4 = 40% speed	4 =Red green fade 1 step between
7	5 = 50% speed	5 =Red blue fade 1 step between
7	6 = 60% speed	6 =Blue green fade 1 step between
7	7 = 70% speed	7 =RGBW fading not step between
7	8 = 80% speed	8 =RGBW fading 1 step between
7	9 = 90% speed = fastest	9 =RGBW no fade, no step between

General remark

The activation of channel 13 does not interfere with the operation in 'stand alone control' of the card. The presence of DMX-signal to at the input of the card does not interfere with the operation of the 'stand alone control' of the card.

Service and maintenance

9.1 Safety precautions



Read carefully the safety information in this manual. Lock out the power on the entire system and allow all electronic devices to discharge, and cool down, before executing any service or maintenance.

9.2 Cleaning

LED driver card itself

Extensive dirt and particle build-up degrade performance and may cause overheating. This can result in damaged board and power supplies. Damage by inadequate cleaning or maintenance is not covered by the product warranty.



Never use solvents to clean the outer housing of the card.

Never use water or wet cloth.

Enclosure, in which the card is integrated

Best is to use compressed air to remove dust, or soft cloth to remove the dust in the cabinet. When using compressed air, care must be taken not to damage the fans in the enclosure. Never use solvents to clean the outer housing of the enclosure.

9.3 Monitoring

Two led's are located at left side of the address setting wheel.



The led's indicate the status of the card like shown below:

Colour led	Red	Green
Name led	Power	DMX
Position led	Towards observer	Away from observer
Status led =ON	Power is present at the power input in range from 6V to 48 V	Valid DMX-signal is present.
Status led =Off	No power is present, or microprocessor is not working properly	No Valid DMX-signal is present
Status led = blinking	Card operates in standalone mode.	DMX-signal is dropped. (it was present before)

9.4 Fuse replacement

Safety precautions



Warning! Lock out the power to the entire system, before servicing, or opening any cover. Replace fuses only with ones of same type and rating only. Never attempt to bypass a fuse.

Fuse replacement

The fuse can be found at right side of the power supply input clamps located at left bottom side of the LED driver card.

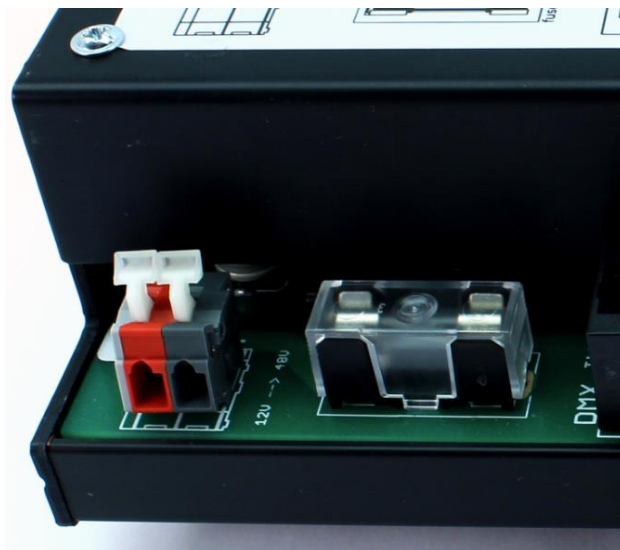

After ensuring yourself that no power is present at the input terminals, remove the plastic fuse-cover, and replace the fuse with a 6.3A F type fuse.

9.5 Software updates

Availability of software updates

At moment of publishing this manual, April 2019, the latest available firmware version = v5.3

Troubleshooting

Led	Led Status	Problem	Action
RED	On	Power is applied to the card.	Check the status of the green led.
	Off	No power is applied to the card.	Check the fuse, and the incoming power supply.
	Blinking	The card is operating in stand-alone mode.	If the card is supposed to be used with a valid DMX-signal, change the DMX address to a valid number
GREEN	On	A valid DMX-signal is detected.	Check the output of your driver DMX device. Check the led-strings.
	Off	No valid DMX-signal is detected, nor does the card run in stand-alone mode.	Check the output of your DMX driver, and check you DMX cabling.
	Blinking	There was for certain time a valid DMX-signal, but for unknown reason, the DMX signal dropped.	Check the output of your DMX driver, and check you DMX cabling.

Specifications

11.1 Electrical

Inputs

- 10 to 48 volt
- 1.2 to 160 watt power consumption depending on configuration of your complete setup.
- Power input on Cage clamp®
- DMX input and feed through on UTP connectors
- DMX start address settable with rotating wheels
- Status leds for DMX and power input
- Input for remote addressing wheel present
- Fuse 6.3 A on board

Outputs

- 12 independent controllable outputs
- Each output capable of driving 350mA load over a voltage of maximum 48 volt DC in PWM dimming mode.
- Stand alone mode possible without DMX-signal.
- Outputs grouped in RGBW mode, on Cage clamp®

11.2 Environmental

- IP rating: IP 20
- Humidity: 30% to 95%
- Ta (max): +40 °C (104 °F)
- Ta (min): -15 °C (+5 °F)
- Tc (max): +55 °C (131 °F)

11.3 Extra features

- Stand-alone mode possible, with different programs and speed settings.
- Possibility to activate a 13th channel, which acts as an effect control channel.

11.4 Mechanical

Physical dimensions of the card below:

Dimensions LED driver card	167x 110 x 70	mm
Dimensions packaging	230 x 230 x 130	mm
Weight LED driver card	390	gr
Weight packaging	500	gr

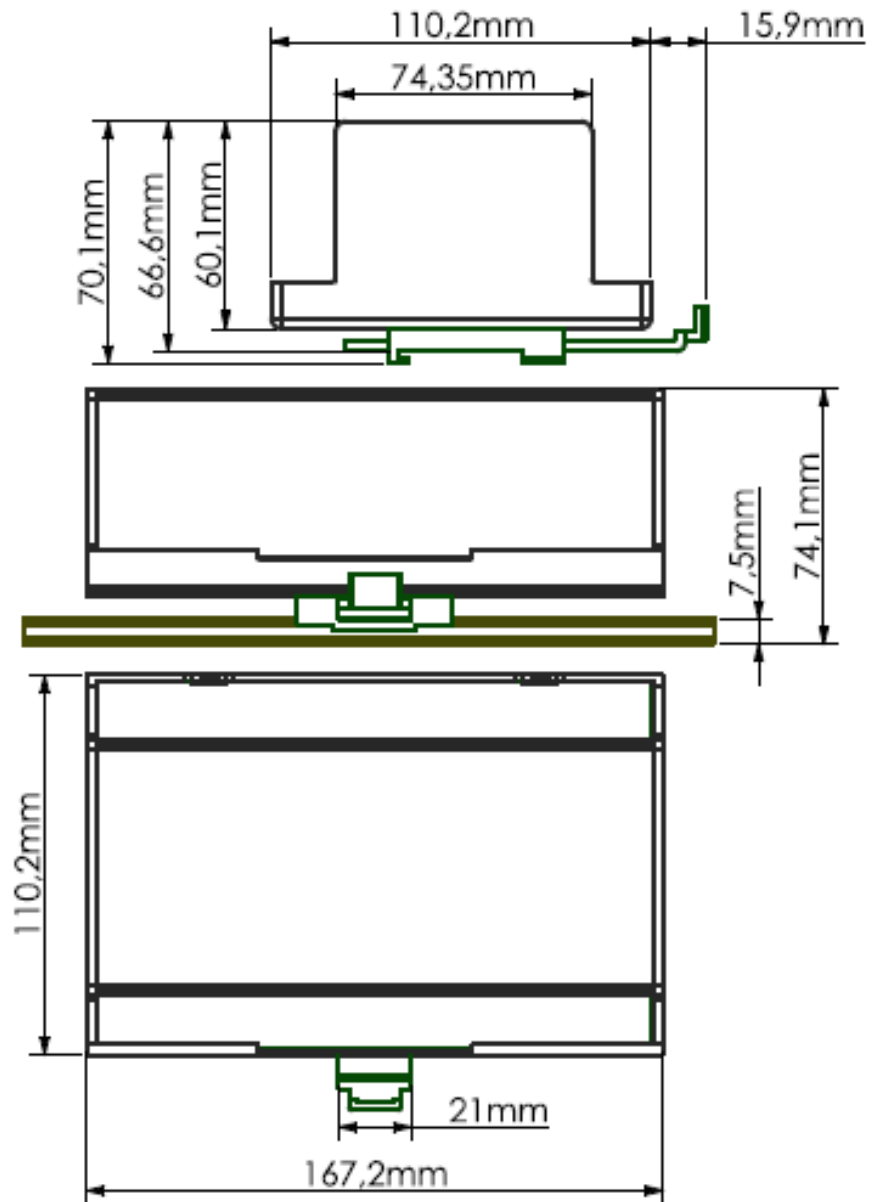

Warranty

12.1 Application of warranty

Warranty period

Warranty service is valid for one year from the date of purchase by the consumer, as evidenced by invoice date given out by your point of sale.

Warranty service

Service under warranty can only be done by Lux Lumen.

Coördinaties:

Lux Lumen
Kernenergiestraat 53 A
2610 Wilrijk
Belgium

Any cost of secure transportation of the product to and from Lux Lumen service department, will be borne by the customer.

Limitations

Lux Lumen will not warrant the following:

- Periodic check-ups, maintenance and repair or replacement of parts due to normal wear and tear.
- Consumables
- Any software
- Defects caused by modifications carried out without Lux Lumen's approval.
- Damage resulting from the fact that a product is not conforming to country specific standards or specifications in another country than the country of purchase.

Costs incurred by Lux Lumen's service center in making any adoptions or modifications of a product necessary for country specific technical or safety standards or specifications, or any other cost to adjust the product as a result of any specifications which have changed since the delivery of the product.

Warranty service is excluded if damage or defects have been caused by:

Improper use, extensive use, handling or operation of the product as referred to in the user manual or operator manual and/or relevant user documents, including without limitation, incorrect storage, dropping, excessive shocks, corrosions, dirt, water, or sand damage, if the product is not rated to be used in severe conditions, indicated by its IP and IK degree, mentioned in the product specifications in this manual.

Repairs, modifications or cleaning carried out by a non Lux Lumen service centre.

Use of spare parts, software or consumables, which are not compatible with the product.

Connecting the product to equipment not intended to be used with this product.

Defects caused by improper condition of the power supply network.

Inadequate packaging of the product when returning it under the RMA procedure.

Accidents or disasters or any cause beyond the control of Lux Lumen, including but not limited to lightning, water, fire, public disturbances, improper ventilation, and acts of god.

Others

It is the responsibility of the customer to backup and save any software files and programs before repair and to restore the same after such repair.

This warranty does not affect the consumer's statutory rights under applicable national legislation in force, nor the consumer's rights against the retailer arising from the sales/purchase contract. In the absence of applicable national legislation, this warranty will be the consumer's sole and exclusive remedy, and Lux Lumen cannot be liable for any incidental or consequential damages for breach of any express or implied warranty of this product.

For full details of the warranty offered on this product, please contact Lux Lumen's service center.

12.2 RMA procedure

To send material back to Lux Lumen, you need a RMA (Return Material Authorization) document that you will receive from Lux Lumen.

Without the RMA document, we cannot accept the material.

The procedure to obtain a RMA:

Step 1:

Customer contacts Lux Lumen about warranty, defects if material has to be returned.

Step 2:

Lux Lumen sends the customer a filled out RMA document (using a unique RMA number)

Step 3:

Customer sends material (include a copy of the RMA document with the material)

Step 4:

Lux Lumen evaluates the problem, and informs the client if repair is done under warranty or makes an offer to the client for repair.

Step 5:

The procedure related to lux lumen quality procedures, according ISO 9001 is started up.

Used list of abbreviations

- DMX: digital multiplexed data signal to according to USITT
- PCB: printed circuit board
- PWM: Pulse width modulation
- CAT 5: category 5 cable
- CAT 6: category 6 cable
- U_f : Forward voltage of the LED junction
- AC: Alternating current
- DC: Direct current
- °F: Temperature in degrees Fahrenheit
- °C: Temperature in degrees Celsius
- Din-rail: rail used in electrical installation, according to 'Deutsche Industry Norm' specifications
- LED: Light Emitting Diode